

記號 MARK	設變內容 MODIFICATION	日期 DATE	修改 DRAW	核准 APPROVE
△	RELEASED	08/02/2006		
△	電鍍標準更新	03/10/2016		

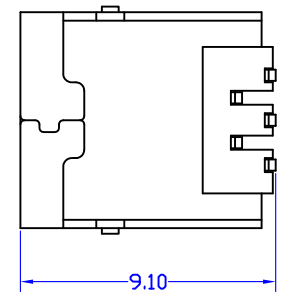
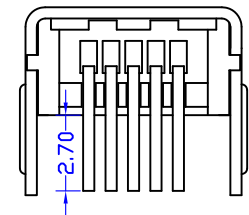
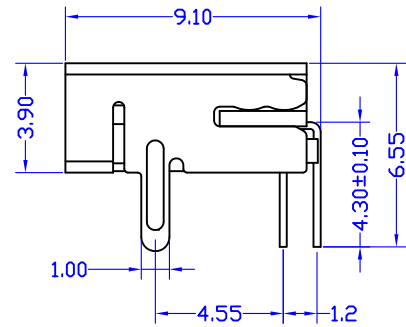
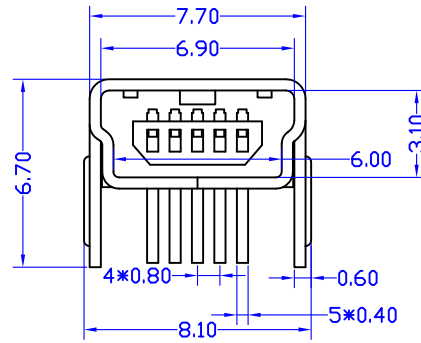
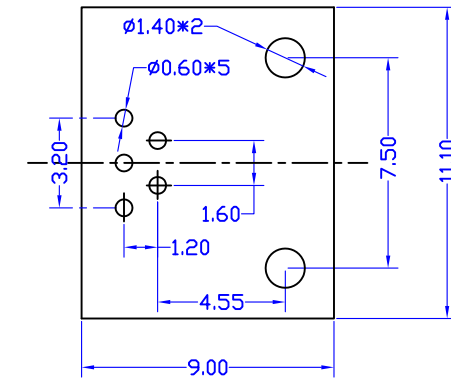
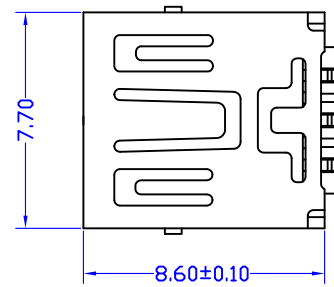
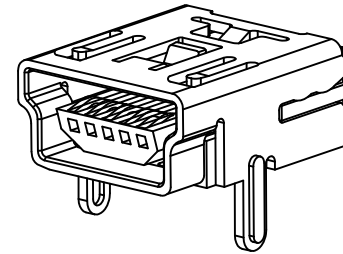

NOTE:

- MATERIAL:
 - HOUSING: PA9T GLASS FIBRE UL94 V-0; BLACK
 - CONTACT: PHOSPHOR BRONZE T=0.25±0.02mm
(SURFACE PLATING: 鍍金0.6u"以上+鍍錫80u"以上+鍍底) △
 - SHEEL: BRONZE T=0.40±0.02mm
(SURFACE PLATING: 鍍鍍60u"以上) △
- ELECTRIC:
 - CONTACT RESISTANCE: 30 MILLIOHMS MAX
 - INSULATION RESISTANCE: 1000 MEGA OHMS MIN
 - DIELECTRIC VOLTAGE: 500V AC ONE SEC LEVEL
 - OPERATING TEMPERATURE: -55°C~ 105°C

UNLESS OTHERWISE SPECIFIED TOLERANCES ARE .x ±0.30 .xx ±0.20 .xxx ±0.10 .x° ±3.0° .xx° ±2.0° .xxx° ±1.0°	承永實業有限公司 BLUE SOURCES ELECTRONICS CO.,LTD.					
	繪圖 / 日期 Draw By/Date	2007.03.11	單位 Units	MM	名稱 / 料號 Title / Part NO.	MINI USB 5P/F B TYPE DIP D款成品2脚(打型) MU-BF0561-1B
	審核 / 日期 Check By/Date		比例 Scale	1:1	材質 Material	PBT 顏色 Color
	批准 / 日期 App. By/Date		頁次 SHEET	1/1	角法 PROJ.	版本 REV. A